

PGA108L

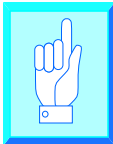
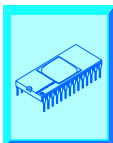
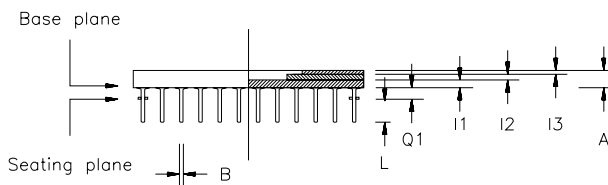
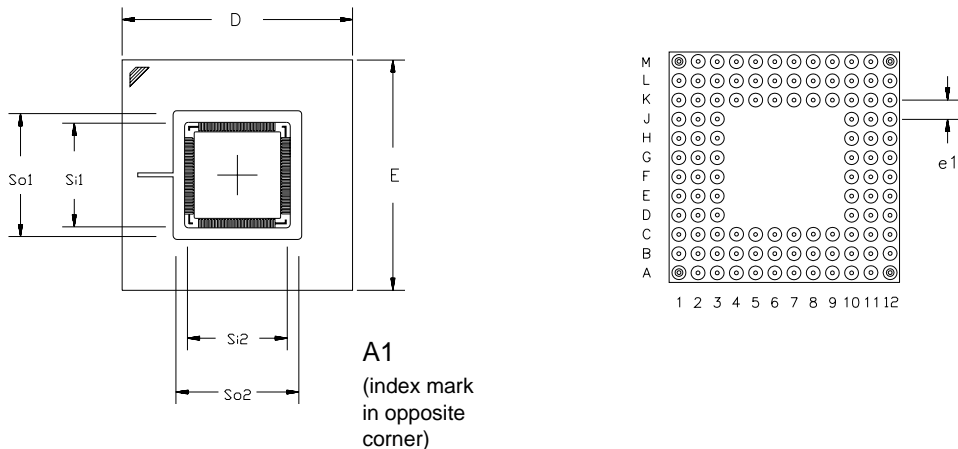
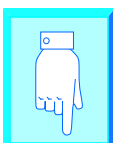

Table of Contents



Exit



Dimension	Designation	Nominal	Units/Material
A	Base plane height	0.080	in
Q1	Seating-Base plane	0.050	in
D,E	Overall length	1.200	in (square)
e1	Lead pitch	0.100	in
L	Pin length	0.130	in
N	Pin count	108	
I1	Layer 1 thickness	0.080	in (ceramic)
I2	Layer 2 thickness	0.020	in (ceramic)
I3	Layer 3 thickness	0.020	in (ceramic)
Package	PGA108L	See appendix B	

Scale: 1X

Dimension	Designation	Nominal	Units/Material
Si	Seal ring ID	0.670	in (square)
So	Seal ring OD	0.570	in (square)
Lid	F0650S	See appendix A	

NOTE: Rotate diagram 90 degrees clockwise.

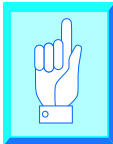
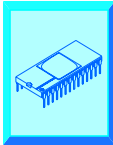
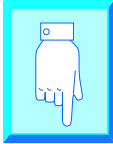

Table of Contents



Exit



PGA108L

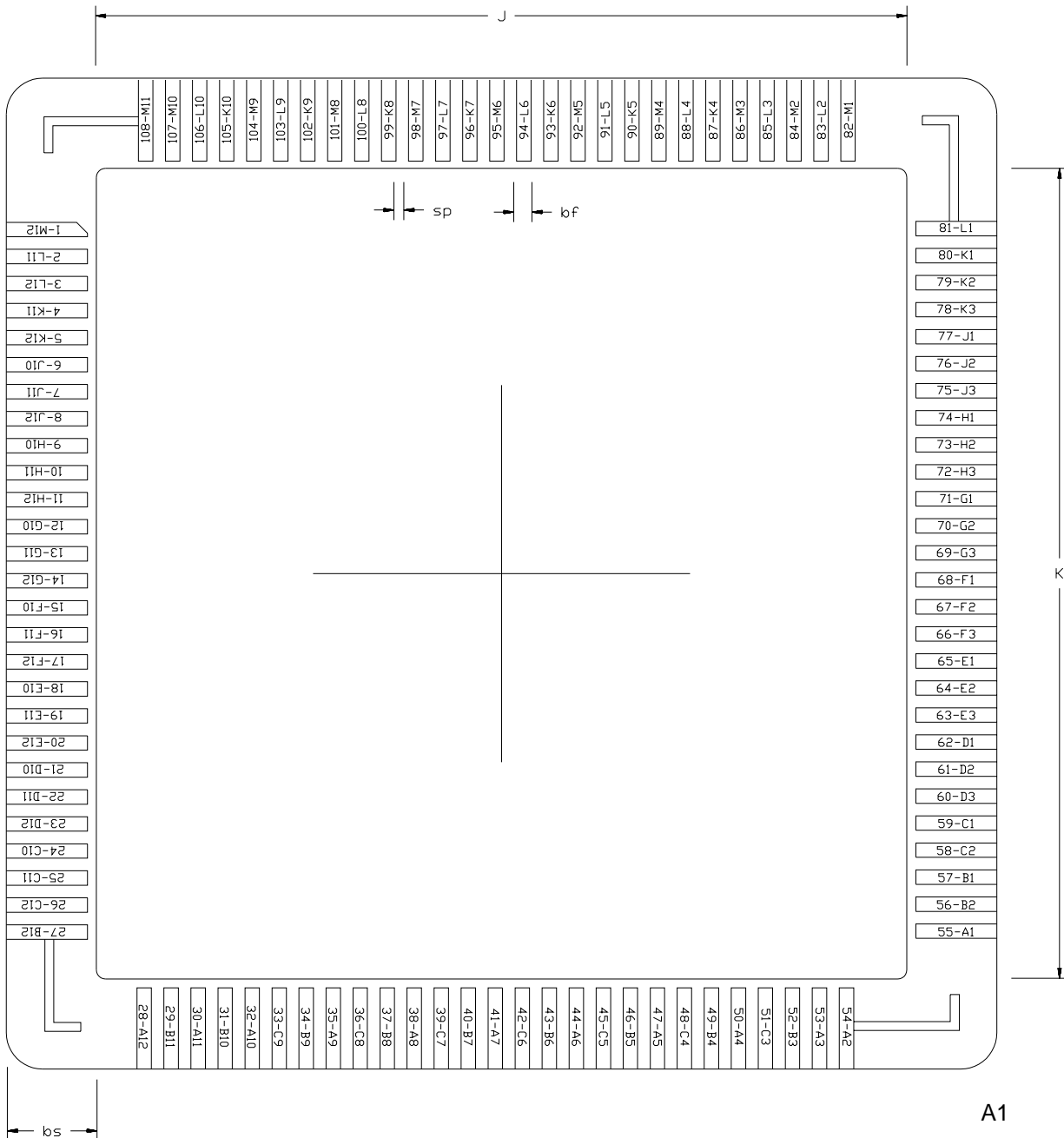

Dimension	Designation	Nominal	Units/Material
J,K	Cavity length/width	0.450	in (square)
bs	Bond shelf width	0.050	in
sp	Bond finger spacing	0.007	in
bf	Bondfinger width	0.008	in

View of bottom of package

M	82	84	86	89	92	95	98	101	104	107	108	1	
L	81	83	85	88	91	94	97	100	103	106	2	3	
K	80	79	78	87	90	93	96	99	102	105	4	5	
J	77	76	75								6	7	8
H	74	73	72								9	10	11
G	71	70	69								12	13	14
F	68	67	66								15	16	17
E	65	64	63								18	19	20
D	62	61	60								21	22	23
C	59	58	51	48	45	42	39	36	33	34	24	25	26
B	57	56	52	49	46	43	40	37	34	31	29	27	28
A	55	54	53	50	47	44	41	38	35	32	30	28	

1 2 3 4 5 6 7 8 9 10 11 12

PGA108L

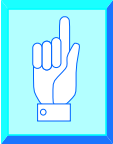
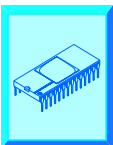

Table of Contents



Exit



M	82	84	86	89	92	95	98	101	104	107	108	1
L	81	83	85	88	91	94	97	100	103	106	2	3
K	80	79	78	87	90	93	96	99	102	105	4	5
J	77	76	75							6	7	8
H	74	73	72							9	10	11
G	71	70	69							12	13	14
F	68	67	66							15	16	17
E	65	64	63							18	19	20
D	62	61	60							21	22	23
C	59	58	51	48	45	42	39	36	33	24	25	26
B	57	56	52	49	46	43	40	37	34	31	29	27
A	55	54	53	50	47	44	41	38	35	32	30	28

1 2 3 4 5 6 7 8 9 10 11 12

Pin Side view of package

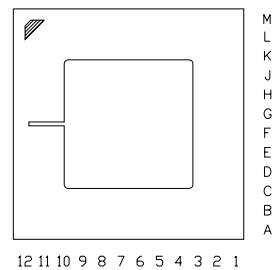

PGA108L

Bond Finger - Pin Interconnect Chart

Bond finger	Pin	Bond finger	Pin	Bond finger	Pin	Bond finger	Pin	Bond finger	Pin
1	M12	24	C10	47	A5	70	G2	93	K6
2	L11	25	C11	48	C4	71	G1	94	L6
3	L12	26	C12	49	B4	72	H3	95	M6
4	K11	27	B12	50	A4	73	H2	96	K7
5	K12	28	A12	51	C3	74	H1	97	L7
6	J10	29	B11	52	B3	75	J3	98	M7
7	J11	30	A11	53	A3	76	J2	99	K8
8	J12	31	B10	54	A2	77	J1	100	L8
9	H10	32	A10	55	A1	78	K3	101	M8
10	H11	33	C9	56	B2	79	K2	102	K9
11	H12	34	B9	57	B1	80	K1	103	L9
12	G10	35	A9	58	C2	81	L1	104	M9
13	G11	36	C8	59	C1	82	M1	105	K10
14	G12	37	B8	60	D3	83	L2	106	L10
15	F10	38	A8	61	D2	84	M2	107	M10
16	F11	39	C7	62	D1	85	L3	108	M11
17	F12	40	B7	63	E3	86	M3		
18	E10	41	A7	64	E2	87	K4		
19	E11	42	C6	65	E1	88	L4		
20	E12	43	B6	66	F3	89	M4		
21	D10	44	A6	67	F2	90	K5		
22	D11	45	C5	68	F1	91	L5		
23	D12	46	B5	69	G3	92	M5		

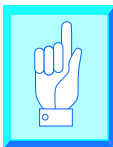
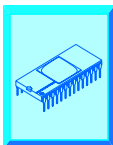
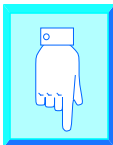

Table
of
Contents



Exit



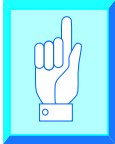
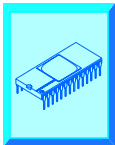
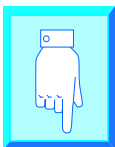

Table of Contents



Exit



PGA108L

Transient Thermal Response

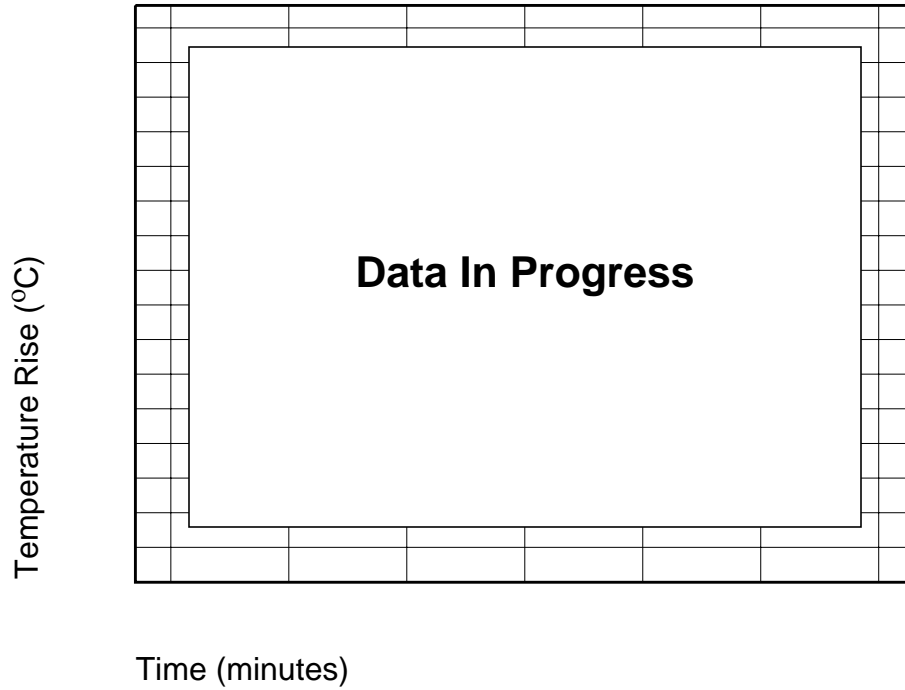

Temperature - Power Relationship

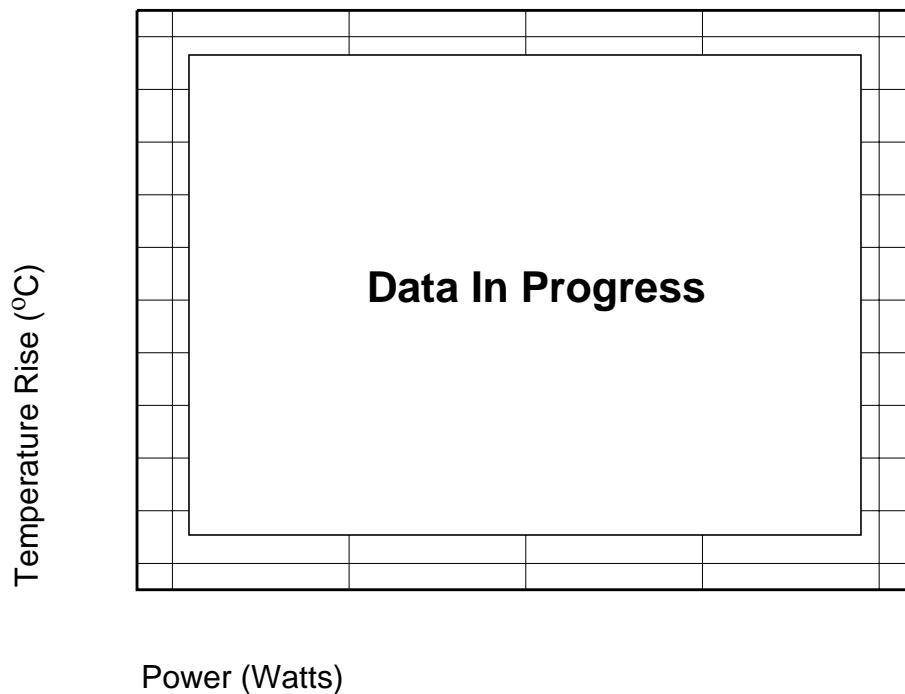

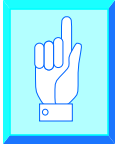
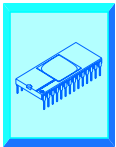
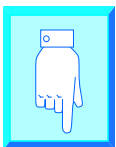

Table
of
Contents



Exit



PGA108L

Thermal Resistance

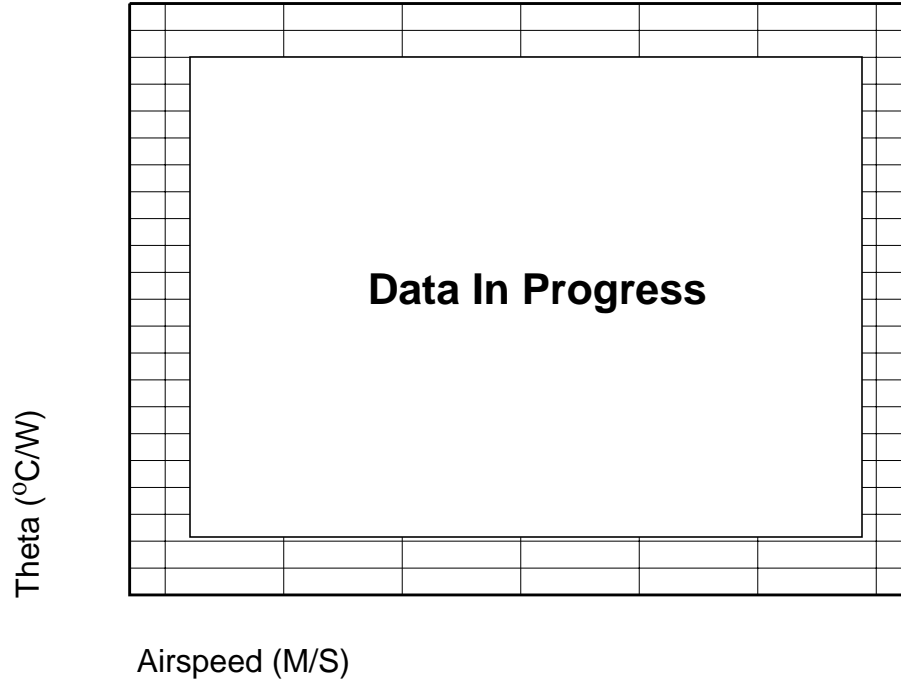

PGA108L

Electrical Characteristics

Bond Finger	$R_1 \Omega$	$L_1 \text{ nH}$	$C_1 \text{ pF}$	$R_2 \Omega$	$L_2 \text{ nH}$	$C_2 \text{ pF}$	$t_{of}(\text{ps})$
12,15,39,42,66,69,93,96	0.172	3.6	1.40	0.291	4.65	1.30	70
9,18,36,45,63,72,90,99	0.205	4.11	1.64	0.291	4.65	1.30	80
10,19,37,46,64,73,91,100	0.216	4.35	1.75	0.189	3.02	0.846	85
6,21,33,48,60,75,87,102	0.234	4.71	1.67	0.291	4.65	1.30	88
13,16,40,43,67,70,94,97	0.243	4.82	1.72	0.189	3.02	0.846	90
24,51,78,105	0.265	5.31	1.93	0.291	4.65	1.30	100
8,23,35,50,62,77,89,104	0.258	5.59	2.00	0.0433	0.693	0.194	105
11,20,38,47,65,74,92,101	0.156	5.03	2.22	0.0433	0.693	0.194	105
14,17,41,44,68,71,95,98	0.158	5.18	2.38	0.0433	0.693	0.194	110
4,25,31,52,58,79,85,106	0.310	6.11	2.22	0.189	3.02	0.846	115
7,22,34,49,61,76,88,103	0.309	6.07	2.26	0.189	3.02	0.846	115
2,29,56,83	0.329	6.50	2.25	0.189	3.02	0.846	120
3,27,30,54,57,81,84,108	0.160	5.45	2.78	0.0433	0.693	0.194	122
5,26,32,53,59,80,86,107	0.157	5.64	2.84	0.0433	0.693	0.194	126
1,28,55,82	0.182	5.88	2.93	0.0433	0.693	0.194	130

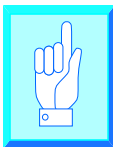
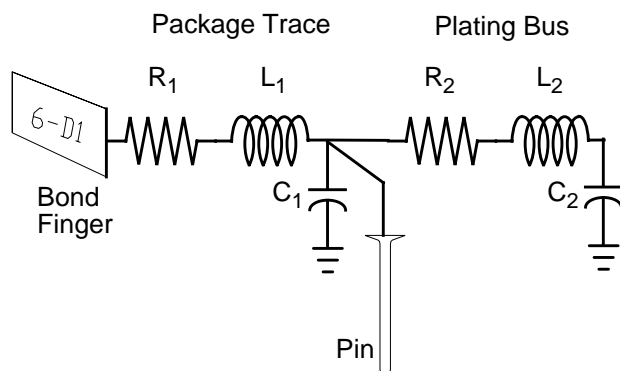
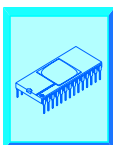

Table of Contents



Exit



PGA108L

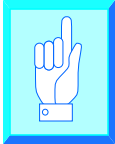
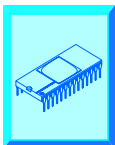

Table of Contents



Exit



Cross-Talk

Trace	Low Z	High Z
Short	Data In Progress	
Long		

% of adjacent signal coupled to nearest neighbor with 1ns rise time

Signal degradation

Trace	Input Risetime (ps)	Output Risetime (ps)
Short	Data In Progress	
Long		

output risetime for a specific input risetime