

# PGA132L

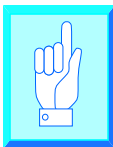
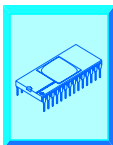
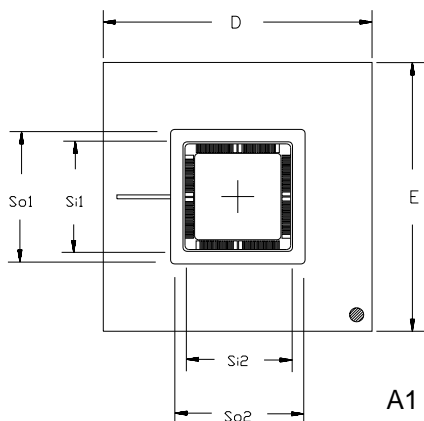

Table of Contents



Exit



A1

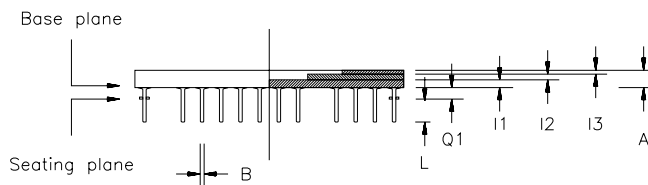
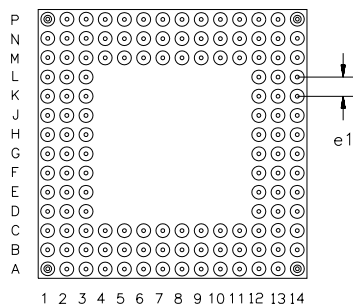

Dimension	Designation	Nominal	Units/Material
A	Base plane height	0.090	in
Q1	Seating-Base plane	0.050	in
D,E	Overall length	1.400	in (square)
e1	Lead pitch	0.100	in
L	Pin length	0.130	in
N	Pin count	132	
I1	Layer 1 thickness	0.045	in (ceramic)
I2	Layer 2 thickness	0.025	in (ceramic)
I3	Layer 3 thickness	0.020	in (ceramic)
Package	PGA132L	See appendix B	

Scale: 1X

Dimension	Designation	Nominal	Units/Material
Si	Seal ring ID	0.570	in (square)
So	Seal ring OD	0.700	in (square)
Lid	F0690S	See appendix A	

NOTE: Rotate this diagram 90 degrees counterclockwise.

# PGA132L

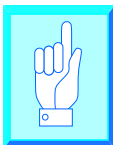
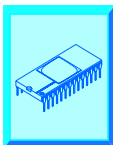
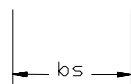
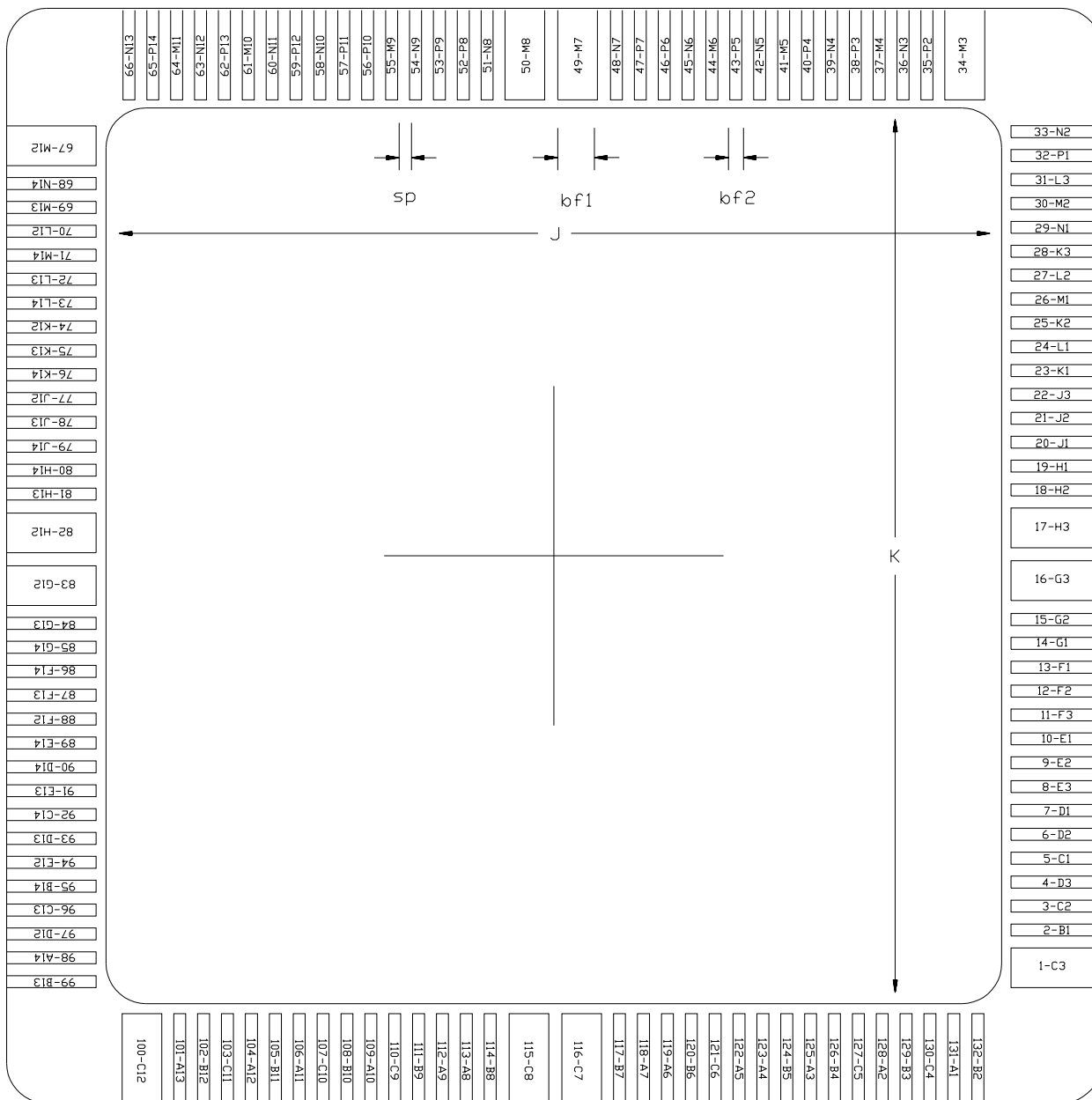
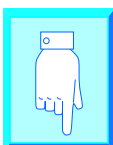

Table of Contents



Exit



A1

Dimension	Designation	Nominal	Units/Material
J,K	Cavity length/width	0.450	in (square)
bs	Bond shelf width	0.050	in
sp	Bond finger spacing	0.006	in
bf1	Bondfinger width	0.020	in
bf2	Bondfinger width	0.006	in

View of bottom of package

P	32	35	38	40	43	46	47	52	53	56	57	59	62	65
N	29	33	36	39	42	45	48	51	54	58	60	63	66	68
M	26	30	34	37	41	44	49	50	55	61	64	67	69	71
L	24	27	31									70	72	73
K	23	25	28									74	75	76
J	20	21	22									77	78	79
H	19	18	17									82	81	80
G	14	15	16									83	84	85
F	13	12	11									88	87	86
E	10	9	8									94	91	89
D	7	6	4									97	93	90
C	5	3	1	130	127	121	116	115	110	107	103	100	96	92
B	2	132	129	126	124	120	117	114	111	108	105	102	99	95
A	131	128	125	123	122	119	118	113	112	109	106	104	101	98

1 2 3 4 5 6 7 8 9 10 11 12 13 14

# PGA132L

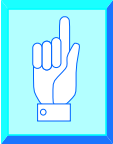
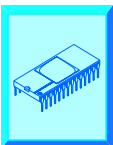

Table of Contents



Exit



P	32	35	38	40	43	46	47	52	53	56	57	59	62	65
N	29	33	36	39	42	45	48	51	54	58	60	63	66	68
M	26	30	34	37	41	44	49	50	55	61	64	67	69	71
L	24	27	31								70	72	73	
K	23	25	28								74	75	76	
J	20	21	22								77	78	79	
H	19	18	17								82	81	80	
G	14	15	16								83	84	85	
F	13	12	11								88	87	86	
E	10	9	8								94	91	89	
D	7	6	4								97	93	90	
C	5	3	1	130	127	121	116	115	110	107	103	100	96	92
B	2	132	129	126	124	120	117	114	111	108	105	102	99	95
A	131	128	125	123	122	119	118	113	112	109	106	104	101	98

1 2 3 4 5 6 7 8 9 10 11 12 13 14

Pin Side view of package

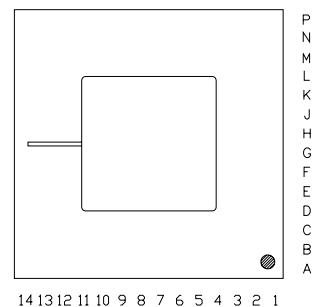

# PGA132L

## Bond Finger - Pin Interconnect Chart

Bond finger	Pin	Bond finger	Pin	Bond finger	Pin	Bond finger	Pin	Bond finger	Pin
1	C3	28	K3	55	M9	82	H12	109	A10
2	B1	29	N1	56	P10	83	G12	110	C9
3	C2	30	M2	57	P11	84	G13	111	B9
4	D3	31	L3	58	N10	85	G14	112	A9
5	C1	32	P1	59	P12	86	F14	113	A8
6	D2	33	N2	60	N11	87	F13	114	B8
7	D1	34	M3	61	M10	88	F12	115	C8
8	E3	35	P2	62	P13	89	E14	116	C7
9	E2	36	N3	63	N12	90	D14	117	B7
10	E1	37	M4	64	M11	91	E13	118	A7
11	F3	38	P3	65	P14	92	C14	119	A6
12	F2	39	N4	66	N13	93	D13	120	B6
13	F1	40	P4	67	M12	94	E12	121	C6
14	G1	41	M5	68	N14	95	B14	122	A5
15	G2	42	N5	69	M13	96	C13	123	A4
16	G3	43	P5	70	L12	97	D12	124	B5
17	H3	44	M6	71	M14	98	A14	125	A3
18	H2	45	N6	72	L13	99	B13	126	B4
19	H1	46	P6	73	L14	100	C12	127	C5
20	J1	47	P7	74	K12	101	A13	128	A2
21	J2	48	N7	75	K13	102	B12	129	B3
22	J3	49	M7	76	K14	103	C11	130	C4
23	K1	50	M8	77	J12	104	A12	131	A1
24	L1	51	N8	78	J13	105	B11	132	B2
25	K2	52	P8	79	J14	106	A11		
26	M1	53	P9	80	H14	107	C10		
27	L2	54	N9	81	H13	108	B10		

# PGA132L

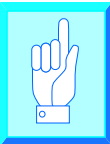
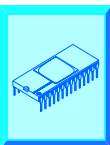

Table of Contents



Exit



### Transient Thermal Response

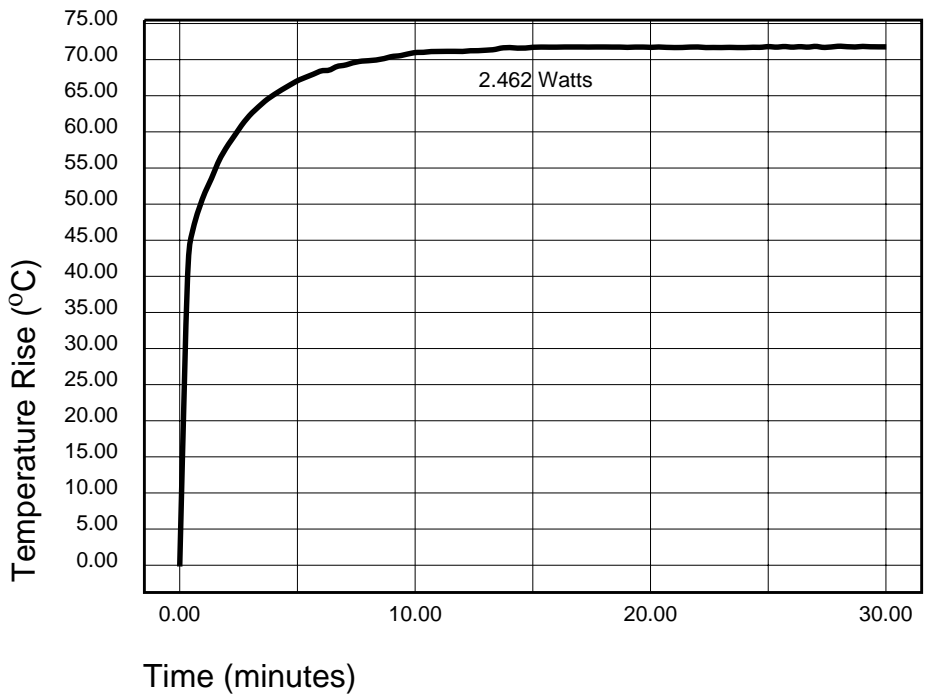

### Temperature - Power Relationship

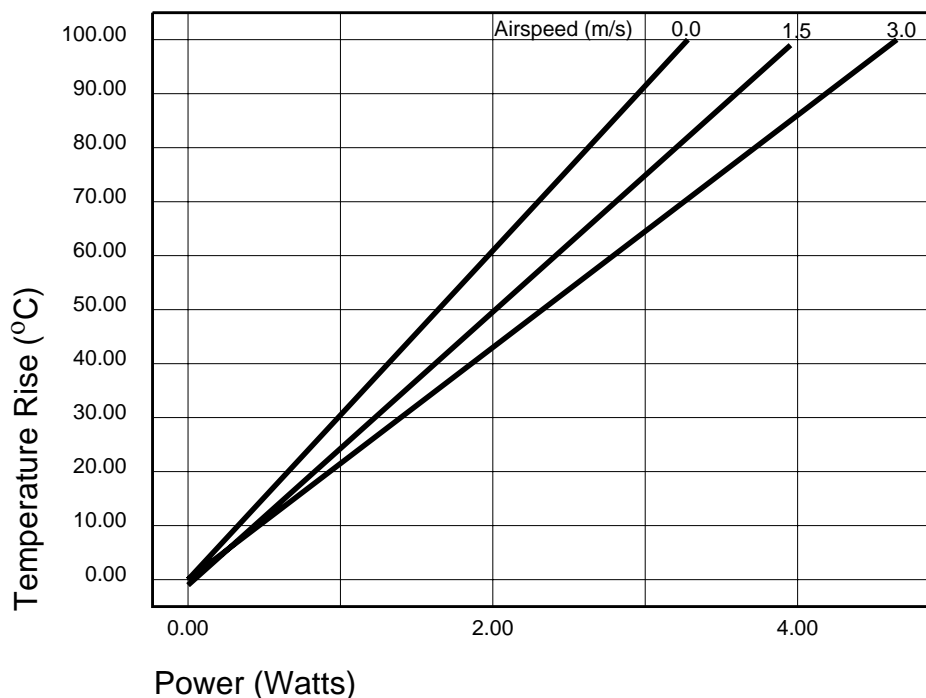

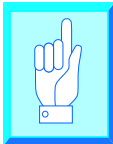
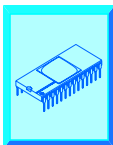

Table of Contents



Exit



# PGA132L

## Thermal Resistance

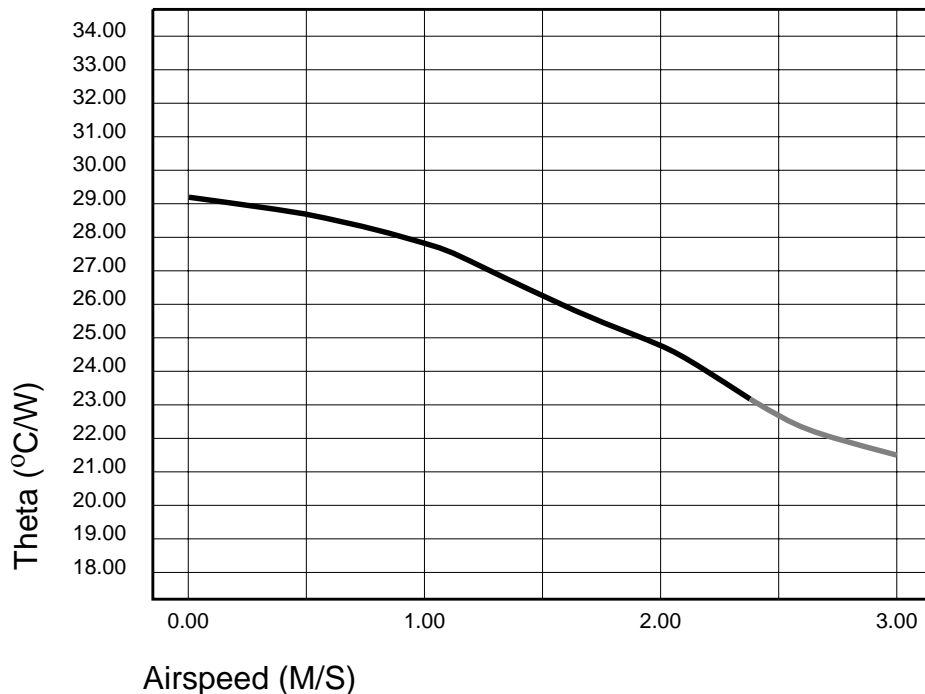

Measured ———

Predicted ———

Thermal test device: "TOAST"  
Die size: 0.153" x 0.133"  
Die Attach material: Abelstick 84LMI silver filled epoxy

# PGA132L

## Electrical Characteristics

Bond Finger	$R_1 \Omega$	$L_1$ nH	$C_1$ pF	$R_2 \Omega$	$L_2$ nH	$C_2$ pF	$t_{of}(ps)$
11,22,44,55,77,88,110,121	0.105	3.46	1.54	0.291	4.65	1.3	72.6
8,28,41,61,74,94,107,127	0.109	3.67	1.77	0.291	4.65	1.3	79.6
16,17,49,50,82,83,115,116	0.125	4.1	1.86	0.291	4.65	1.3	86.6
4,31,37,64,70,97,103,130	0.121	4.03	1.9	0.291	4.65	1.3	86.6
1,34,67,100	0.127	4.16	1.82	0.291	4.65	1.3	86.6
15,18,48,51,81,84,114,117	0.165	5.23	2.18	0.0433	0.693	0.194	107
13,20,46,53,79,86,112,119	0.188	5.54	2.28	0.189	3.02	0.846	112
12,21,45,54,78,87,111,120	0.257	5.93	2.12	0.189	3.02	0.846	112
14,19,47,52,80,85,113,118	0.265	6.11	2.28	0.189	3.02	0.846	117
9,25,42,58,75,91,108,124	0.197	5.82	2.36	0.0433	0.693	0.194	117
3,30,36,63,69,96,102,129	0.189	6.09	2.67	0.189	3.02	0.846	127
6,27,39,60,72,93,105,126	0.243	6.43	2.55	0.189	3.02	0.846	127
10,23,43,56,76,89,109,122	0.359	6.59	2.49	0.0433	0.693	0.194	127
33,66,99,132	0.288	6.71	2.41	0.189	3.02	0.846	127
7,24,40,57,73,90,106,123	0.172	6.52	3.31	0.0433	0.693	0.194	147
5,26,38,59,71,92,104,125	0.373	8.63	3.28	0.0433	0.693	0.194	167
2,29,35,62,68,95,101,128	0.289	8.92	3.47	0.0433	0.693	0.194	176
32,65,98,131	0.288	8.77	3.8	0.0433	0.693	0.194	182

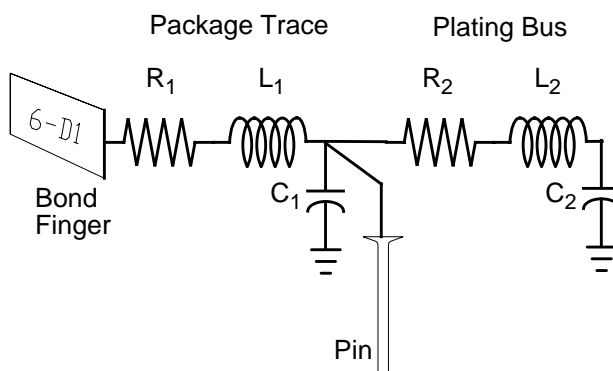

# PGA132L

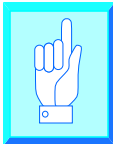
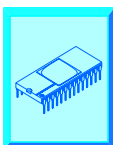

Table of Contents



Exit



## Cross-Talk

Trace	Low Z	High Z
Short	Data In Progress	
Long		

% of adjacent signal coupled to nearest neighbor with 1ns rise time

## Signal degradation

Trace	Input Risetime (ps)	Output Risetime (ps)
Short	Data In Progress	
Long		

output risetime for a specific input risetime